

Original VELUX flashings for reliable installation

# Flashing: EDS 0000



## For flat roofing material up to 8 mm

- A perfect match with VELUX roof window
- Fast installation
- Maintenance-free and no corrosion
- Tested for extreme weather conditions
- VELUX guarantee

### Flashing EDS 0000 features



Flashing material:  
Aluminium  
Dark grey



Roof pitch:  
15°-90°



Profile height:  
max 8 mm,  
Slate or  
roofing felt





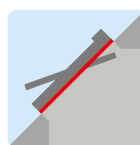





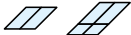



Full side  
sections with  
standing  
groove

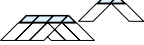

Standard  
installation:  
**Red line level**

## Single and combi-flashings

Flat roofing material: 8 mm		
1		EDS
2		EBS
3		EKS
4		EKS ---7- + EDS
5		EFS
6		EFS --22/32
7		EDS (available from 2015)
8		ETS + EDS
9		ETS + ETS --00- + EKS
10		EKX --88
11		EES + EEX
12		EAS
13		

## Technical drawing

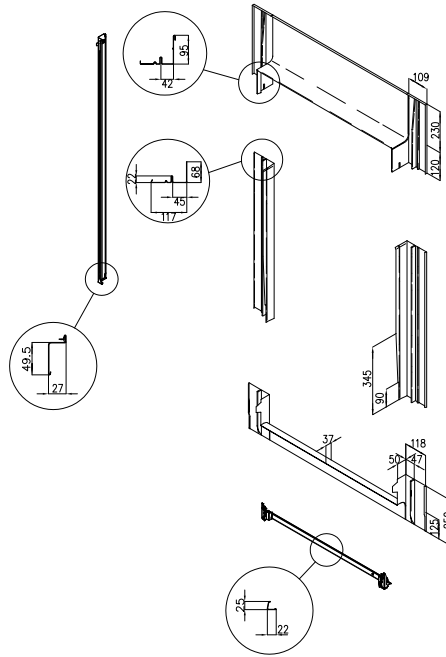

## Technical specifications

Material:	Aluminium alloys
Aluminum thickness:	0,47 mm - 0,65 mm
Coating thick:	Min 24 µm, according to EN 13523-1
Gloss 60°:	30E, according to EN 13523-2
Standard color:	Grey NCS S 7500-N, according to EN 13523-3

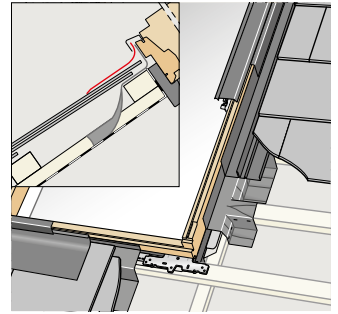

## Available flashing materials

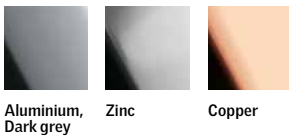

## Benefits



### Reliable and fast installation

A perfect match - designed to fit the window precisely. Convenient, reliable, fast and easy installation. Saves time and money – and gives you satisfied customers.



### Tested for extreme weather conditions

The VELUX flashings have been tested in our wind tunnel – the largest in Northern Europe. Your guarantee for a reliable and durable product.



### Discreet and attractive design

The VELUX flashing design has been proven on millions of roofs world-wide. Pleasing aesthetics, no corrosion, and totally maintenance-free. The wellknown VELUX quality you can trust.



Original



Fast & easy to install



Perfect fit



Weather proof



Warranty



**Contact:**  
 VELUX Denmark A/S  
 Breiltevej xx  
 2970 Hørsholm  
 Support: 2323 4545